

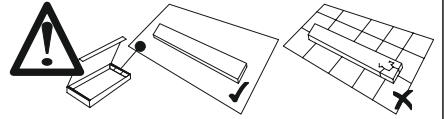

	
3,5x16	
a	x8



LD.270015.000

			
B	x7	K	x2
		N	x4
		O	x4

R

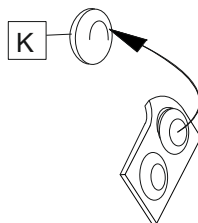
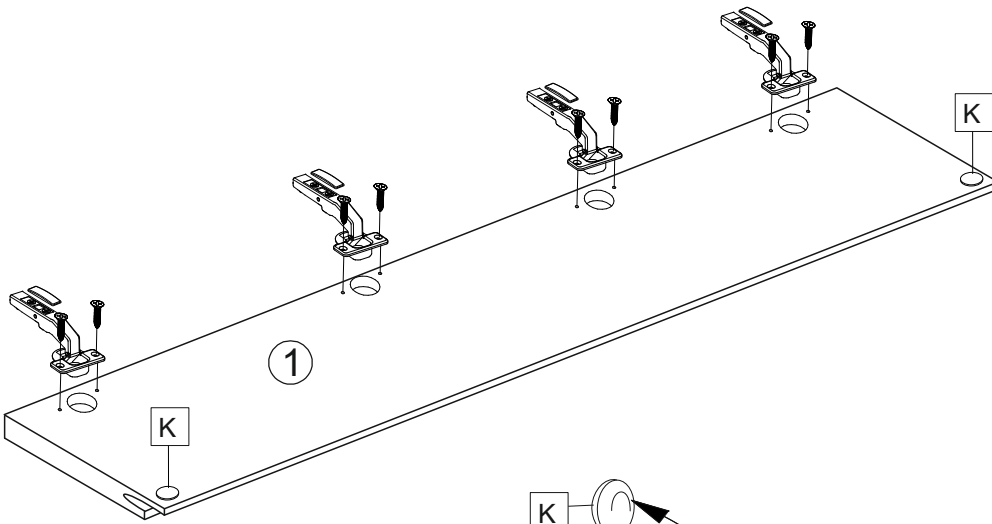
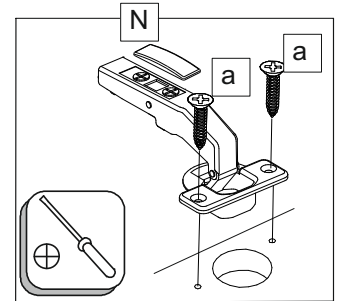
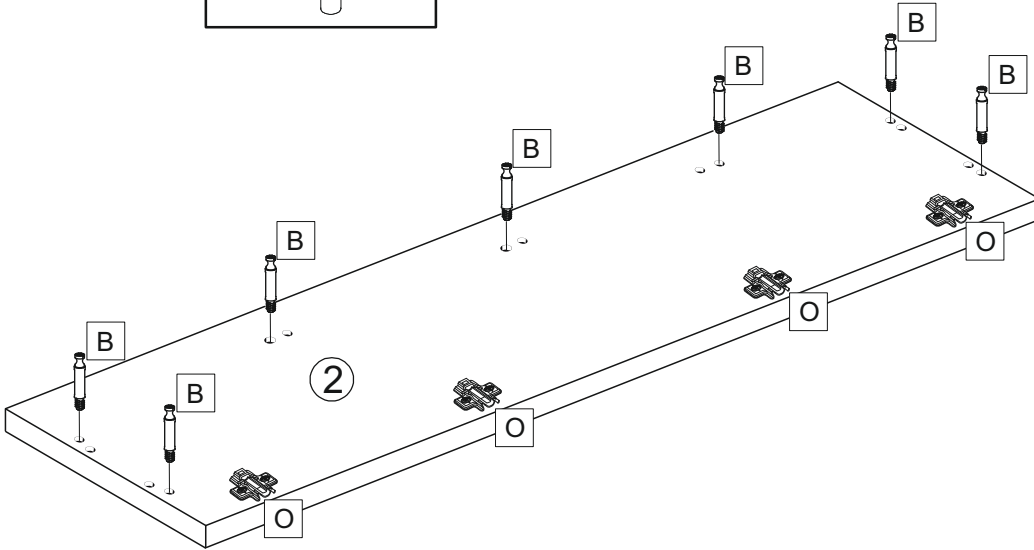
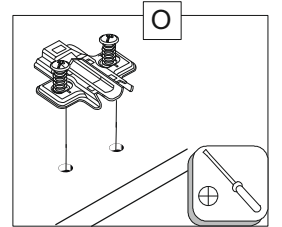
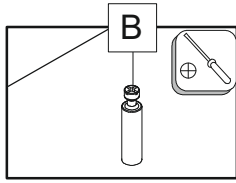



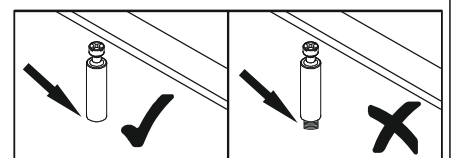

LD.297600.000-2/6

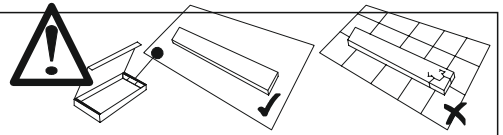

	
3,5x16	
a	x8



LD.270015.000

			
B	x7	K	x2
		N	x4
		O	x4

L

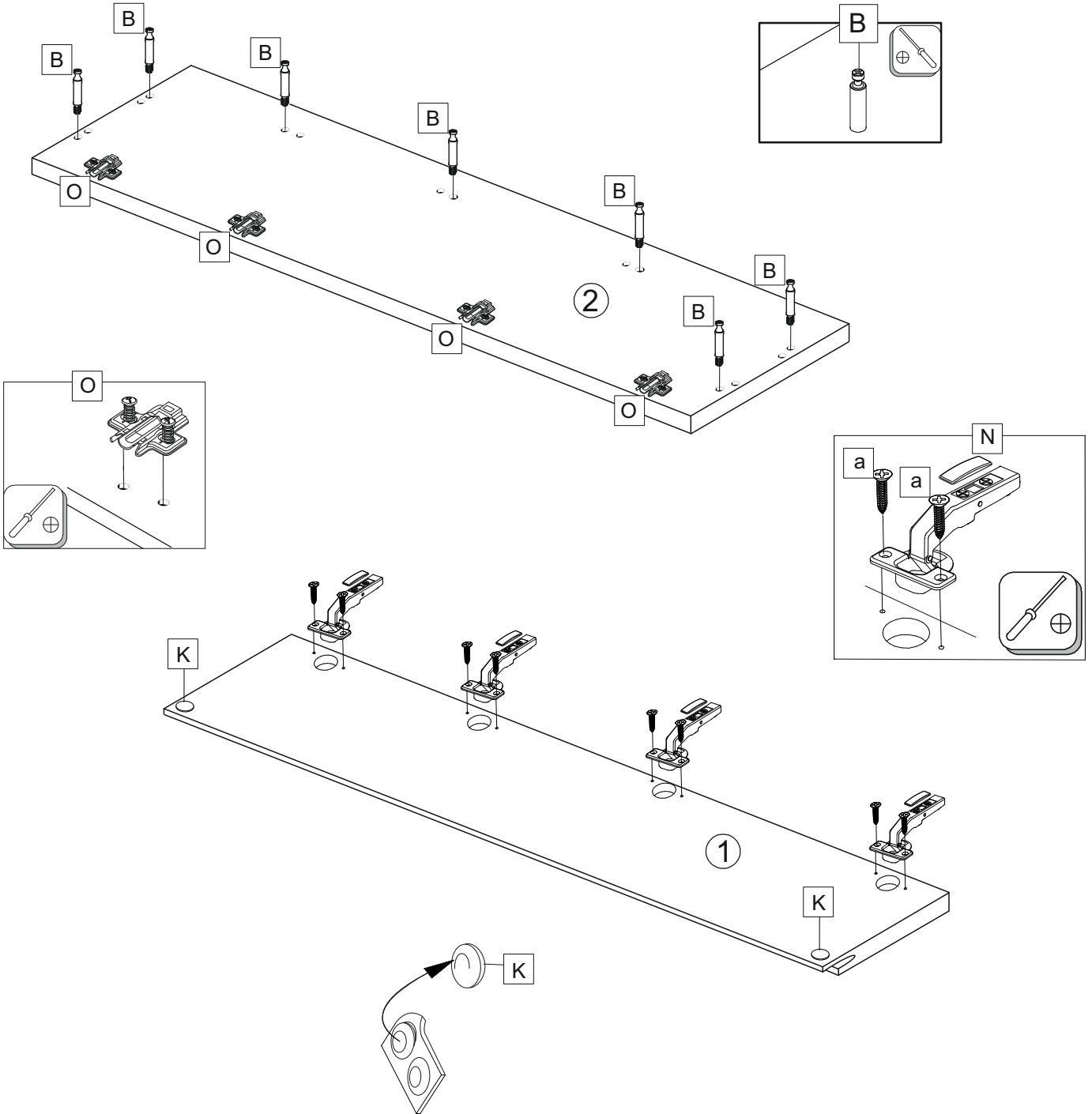

LD.297600.000-2/6

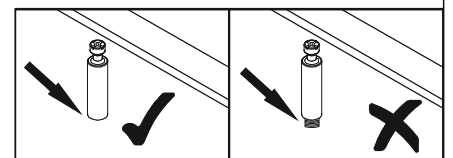



LD.270015.000

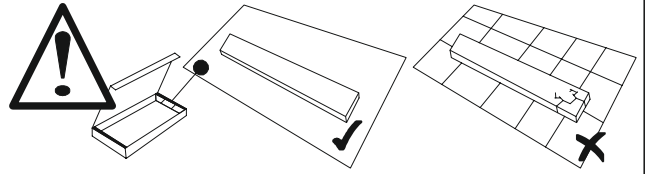
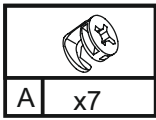

R

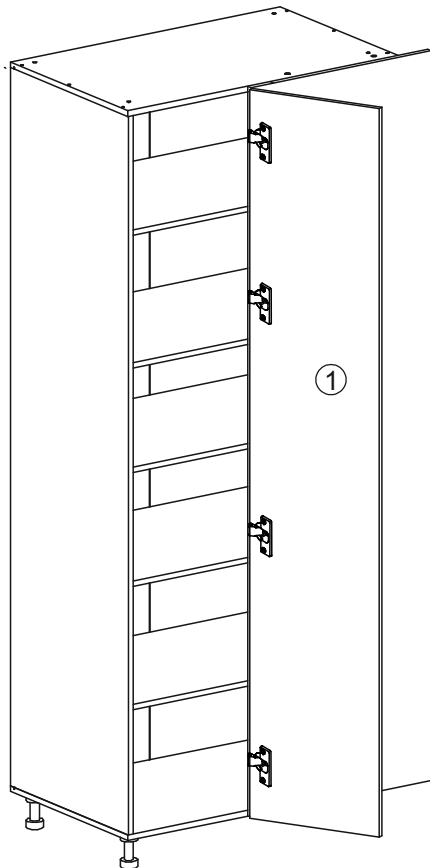
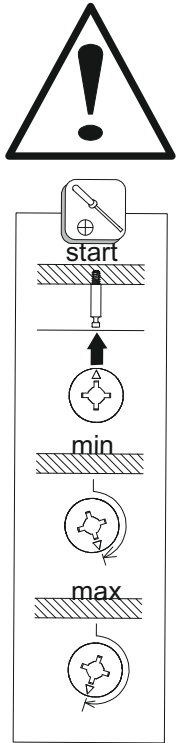
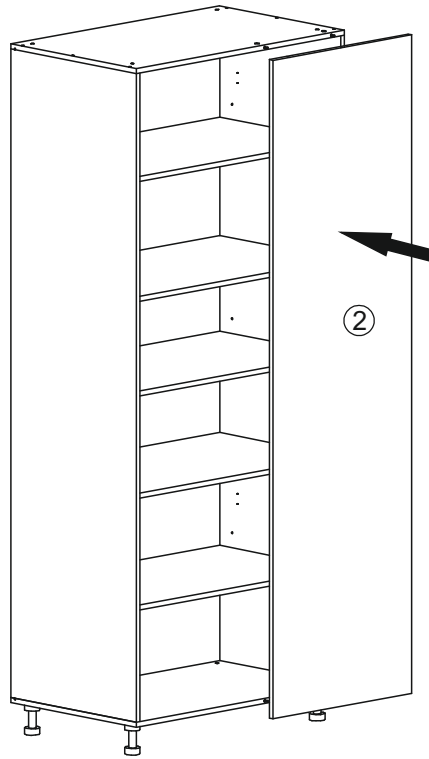
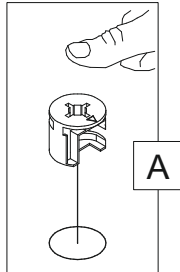
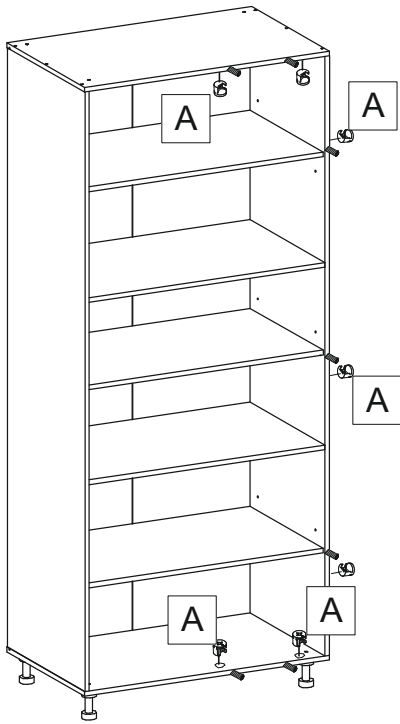

Монтаж

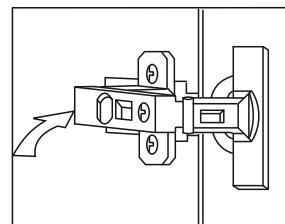
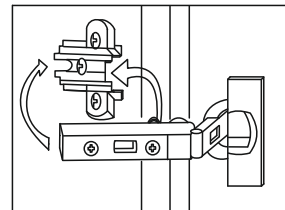

Демонтаж

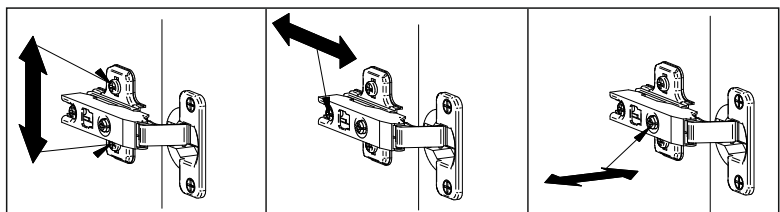
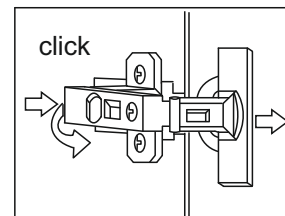

LD.297600.000-4/6



LD.270015.000

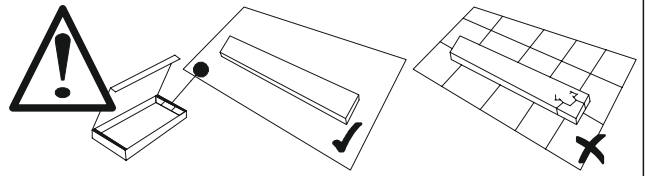
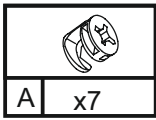

L

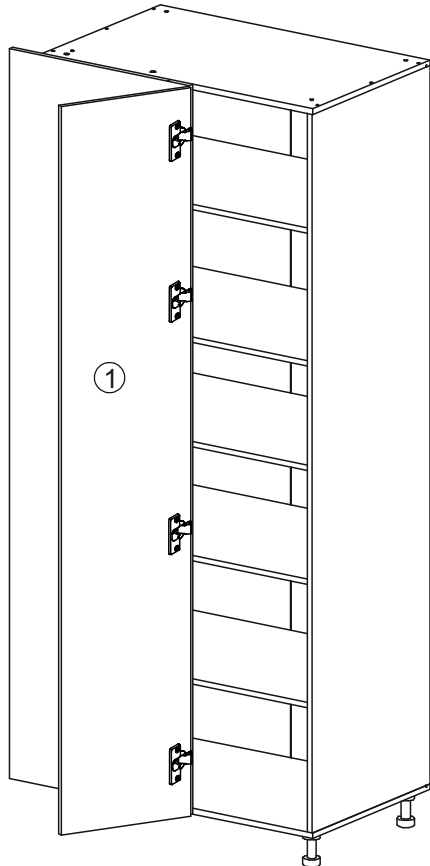
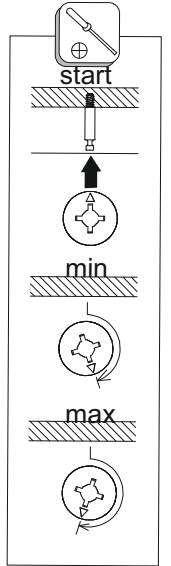
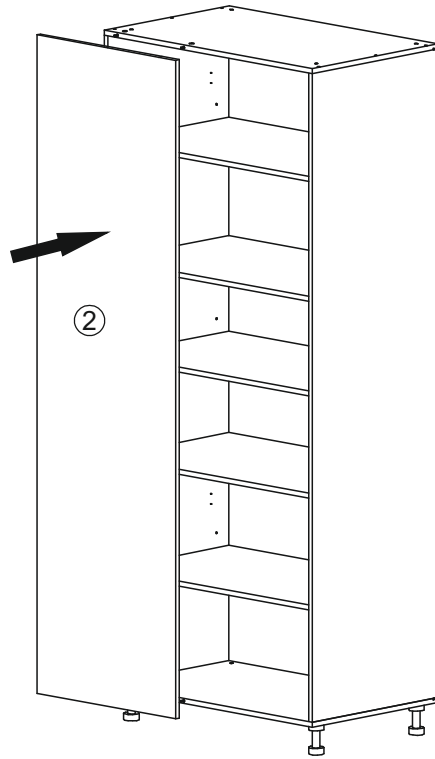
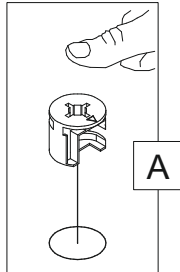
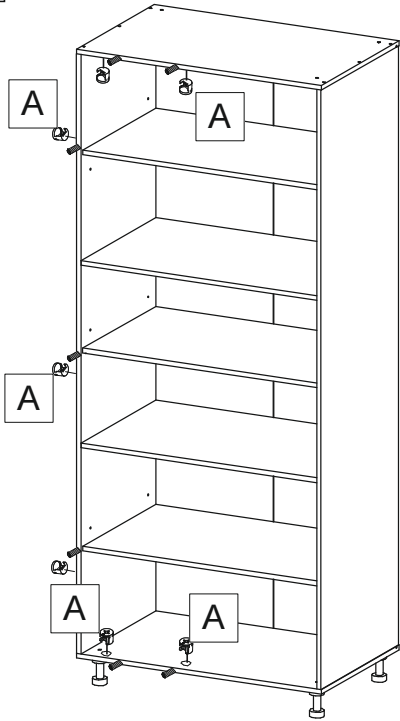

Монтаж

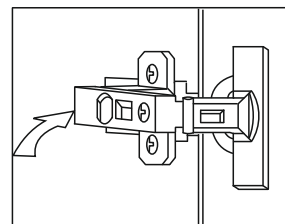
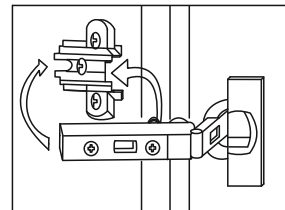

Демонтаж

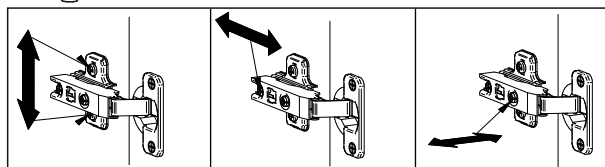
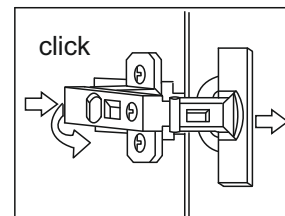

LD.297600.000-5/6

17.01.2024г ф1
Разраб:С.И. №2370